



Pressure relief valves

3 – 15 bar

Pressure relief valves applied in sprayers are ensuring a maximum pressure in order to prevent any bursting hoses or components.

Altek offers fix adjusted relief valves applicable for various pressure levels. The valve housing with AS40 connectors allows an easy and cost saving assembly process.

Due to the big cross section and the aerodynamic housing they can be used for outputs of 400 l/min. For all that, they are very firm and well fitted to the Altek Quick-Fit system.

Überdruckventile





3 – 15 bar

Altek bietet ab Werk fest eingestellte Überdruckventile für unterschiedliche Druckniveaus an. Das Ventilgehäuse ist mit AS40 Anschlüssen ausgestattet. Dadurch ist auch hier eine einfache und kostengünstige Montage gesichert.

Durch die großen Querschnitte und der störungsfreien Durchströmung sind sie für Volumenströme bis zu 400 l/min geeignet.

Dank ihrer besonderen Bauform sind sie dennoch kompakt und lassen sich hervorragend ins Altek Quick-Fit System integrieren.

Overview *Übersicht*

Article no. <i>Artikel-Nr.</i>	Opening pressure <i>Öffnungsdruck</i>	D mm	Colour <i>Farbe</i>
83275	3 bar	33	
83276	6 bar	33	
81493	10 bar	25	
84342	10 bar	AS40	
82994	15 bar	25	



- **Safe and quick assembly using the Altek plug-in system**
Schnelle und sichere Montage durch die Verwendung des Altek Stecksystems
- **Fully integratable with Modular-Fit and Quick-Fit valve series**
Vollständige Integration in die Modular-Fit- und Quick-Fit Serie

Basic parameters *Eigenschaften*

Flow rate <i>Durchfluss</i>	100 — 400 l/min
Material	Stainless steel, POM GF, FPM- and NBR seals Edelstahl, POM GF, FPM- und NBR-Dichtungen

Design *Ausführung*

Zweifache Kolbenabdichtung
Twofold piston sealing

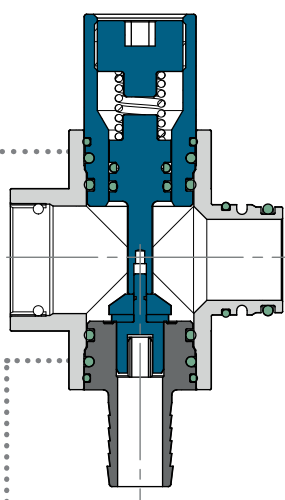

Piston guide
Kolbenführung

Dimensions *Abmessungen*

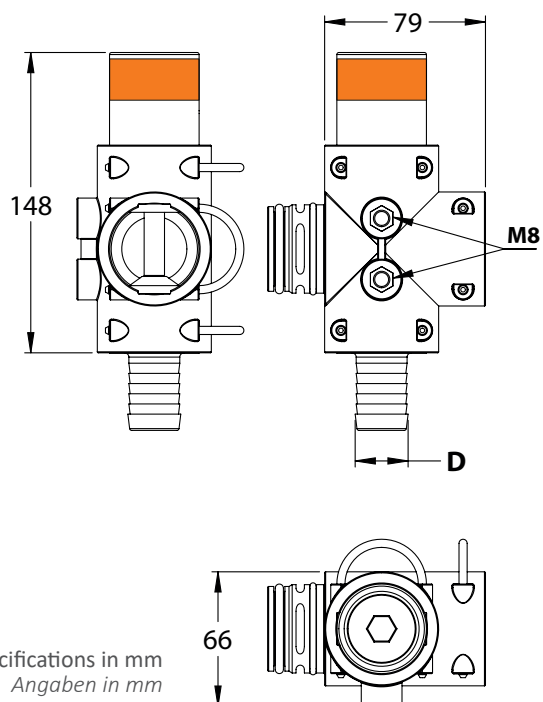

Fittings

AS40

Fittings 131 ff.

Cross piece Kreuzstück

Standard

T piece T-Stück

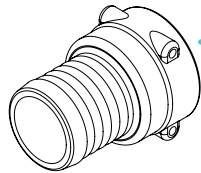

Article no. **Female hose tail**
Artikel-Nr. Stülptülle

AS40	80354	ø 20 mm	↙
AS40	80357	ø 25 mm	↙
AS40	34232	ø 33 mm	↙
AS40	34231	ø 39 mm	↙
AS40	81655	ø 20 mm	┘
AS40	81654	ø 25 mm	┘
AS40	81653	ø 33 mm	┘
AS40	81652	ø 39 mm	┘

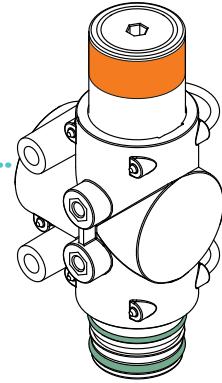
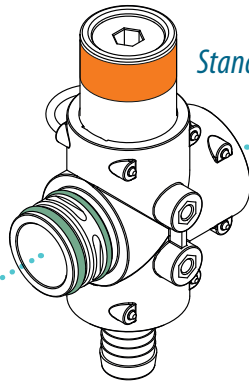

Article no. **Male hose tail**
Artikel-Nr. Stecktülle

AS40	80353	ø 20 mm	↙
AS40	04595	ø 25 mm	↙
AS40	04581	ø 33 mm	↙
AS40	06247	ø 39 mm	↙
AS40	17409	ø 46 mm	↙
AS40	80352	ø 20 mm	┘
AS40	09184	ø 25 mm	┘
AS40	08874	ø 33 mm	┘
AS40	08275	ø 39 mm	┘

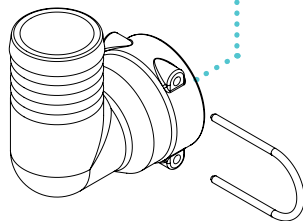

Article no. **Safety Pin**
Artikel-Nr. Sicherungsstecker

18545	AS24
02632	AS30
05241	AS40

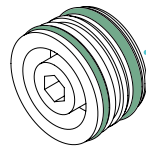
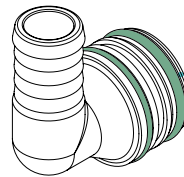
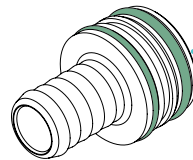

Article no. **Dummy plug**
Artikel-Nr. Blindstopfen

Article no. **Adapter AS / AS**
Artikel-Nr.

AS40	80412	AS24
AS40	83458	AS30

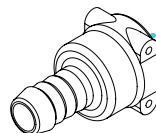
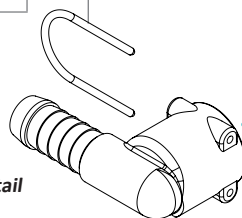

Article no. **Female hose tail**
Artikel-Nr. Stülptülle

AS24	82250	ø 13 mm	┘
AS24	80349	ø 15 mm	┘
AS24	80780	ø 16 mm	┘
AS24	81791	ø 17 mm	┘
AS24	80350	ø 20 mm	┘
AS24	80781	ø 22 mm	┘

AS24	34230	ø 15 mm	↙
AS24	34229	ø 17 mm	↙
AS24	34227	ø 20 mm	↙
AS24	47934	ø 25 mm	↙